

## SINGLE INPUT, TWO OUTPUT SOLID STATE SWITCH

### FEATURES

- Internal PNP Power Transistor
- Reverse Bias Voltage Protection
- Very Low Input-Output Voltage Difference
- Very Low Standby Current
- Overtemperature Protection
- Single Input with Two Controlled Outputs
- Low Noise

### APPLICATIONS

- Battery Powered Systems
- Radio Control Systems
- Automatic Test Equipment (ATE)
- Power Management
- Process Control Equipment
- Power Distribution Control
- Communication Equipment

### DESCRIPTION

The TK70001 is a monolithic bipolar integrated circuit with high side current switches of low saturation type. The current, including the control current, is zero (pA level) when the control pin is "off". The impedance on the output side is high and the reverse current does not flow when the control pin is "off". These are effective to decrease the dissipation currents, making the TK70001 a very efficient device for power management and power distribution control.

The TK70001 is available in a miniature SOT-26 surface mount package. When mounted as recommended, this package is capable of dissipating up to 350 mW.

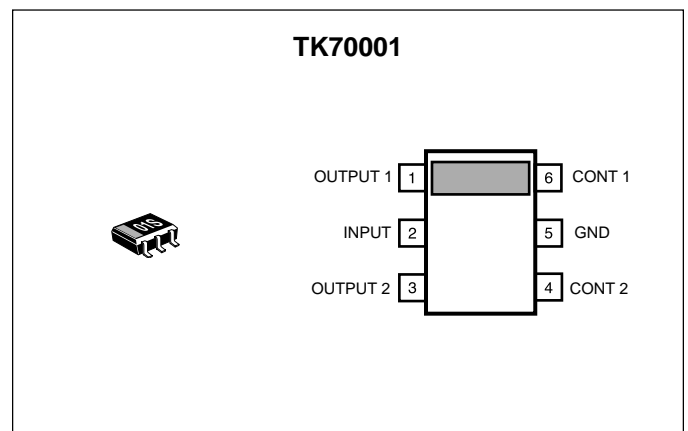

**ORDERING INFORMATION**

**TK70001MCB**

└─ Tape/Reel Code

TAPE/REEL CODE  
 B: Tape Left

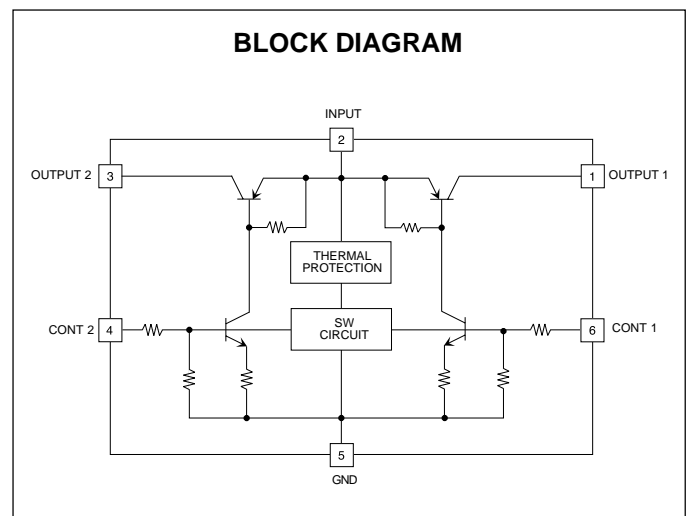

# TK70001

## ABSOLUTE MAXIMUM RATINGS

Supply Voltage .....	14 V	Operating Temperature Range .....	-30 to +80 °C
Output Current .....	130 mA	Operating Voltage Range .....	1.6 to 12 V
Power Dissipation (Note 1) .....	350 mW	Junction Temperature .....	150 °C
Storage Temperature Range .....	-55 to +150 °C	Lead Soldering Temperature (10 s) .....	235 °C

## TK70001 ELECTRICAL CHARACTERISTICS

Test conditions:  $T_A = 25\text{ °C}$ ,  $V_{IN} = 2.5\text{ V}$ , unless otherwise specified.

SYMBOL	PARAMETER	TEST CONDITIONS	MIN	TYP	MAX	UNITS
$I_Q$	Quiescent Current	$I_{OUT} = 0\text{ mA}$ , $I_{CONT} = 50\text{ }\mu\text{A}$		0.6	1.2	mA
$I_{STBY}$	Standby Current	$V_{IN} = 8\text{ V}$ , Output OFF, $V_{CONT} = 0\text{ V}$		0.1	100	nA
$I_{OUT}$	Output Current	$V_{DROP} = 0.5\text{ V}$ , $I_{CONT} = 50\text{ }\mu\text{A}$	60	100		mA
		$V_{DROP} = 0.5\text{ V}$ , $I_{CONT} = 100\text{ }\mu\text{A}$	80	130		mA
$I_{GND}$	Ground Current (Note 3)	$I_{OUT} = 50\text{ mA}$ , $I_{CONT} = 50\text{ }\mu\text{A}$		3.5	5.5	mA
$V_{DROP}$	Dropout Voltage	$I_{OUT} = 50\text{ mA}$ , $I_{CONT} = 50\text{ }\mu\text{A}$		0.17	0.35	V
$\Delta V_D$	Balance Between Channels	$V_{DROP}$ difference, $I_{OUT} = 50\text{ mA}$ , $I_{CONT} = 50\text{ }\mu\text{A}$			50	mV
$I_{REV}$	Reverse Bias Current	$V_{IN} = 0\text{ V}$ , $V_{REV} = 8\text{ V}$ , $V_{CONT} = 0\text{ V}$ , Output OFF		0.02	50	nA
<b>ON/OFF CONTROL TERMINAL</b>						
$I_{CONT}$	Control Terminal Current	$V_{CONT} = 1.6\text{ V}$ , $I_{OUT} = 50\text{ mA}$	50	95	140	$\mu\text{A}$
$V_{CONT(ON)}$	Control Voltage (ON)	Output ON	1.0			V
$V_{CONT(OFF)}$	Control Voltage (OFF)	Output OFF (Note 2)			0.2	V

Note 1: Power dissipation is 350 mW when mounted as recommended. Derate at 2.8 mW/°C for operation above 25°C. Power dissipation is 150 mW in Free Air. Derate at 1.2 mW/°C for operation above 25 °C.

Note 2: By grounding this terminal, the operation completely stops and the input current decreases to a pA level.

Note 3: Ground current is defined as  $I_{IN} - I_{OUT}$ , excluding control terminal current. Refer to "Definition of Terms."

Gen. Note: Parameters with min. or max. values are 100% tested.

Gen. Note: Exceeding "Absolute Maximum Ratings" can damage the device.

TEST CIRCUIT

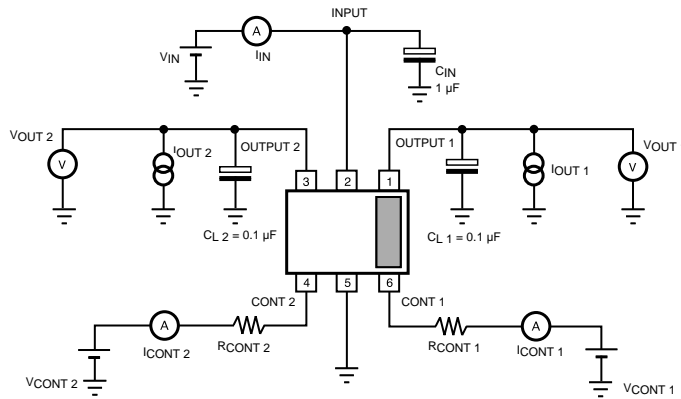

TYPICAL PERFORMANCE CHARACTERISTICS

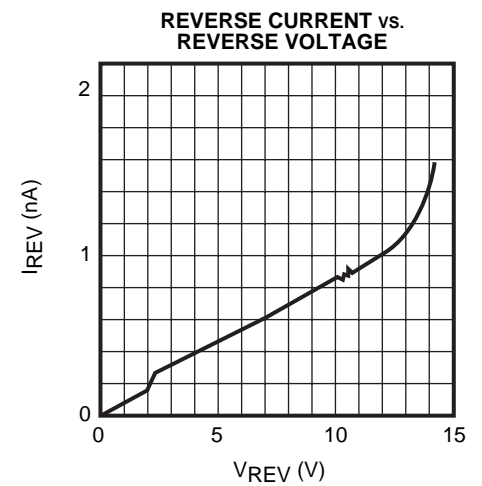
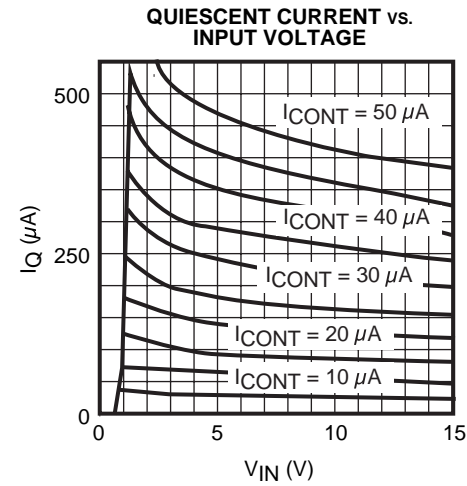
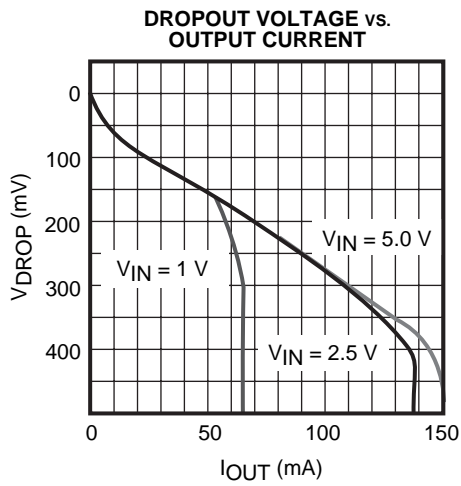
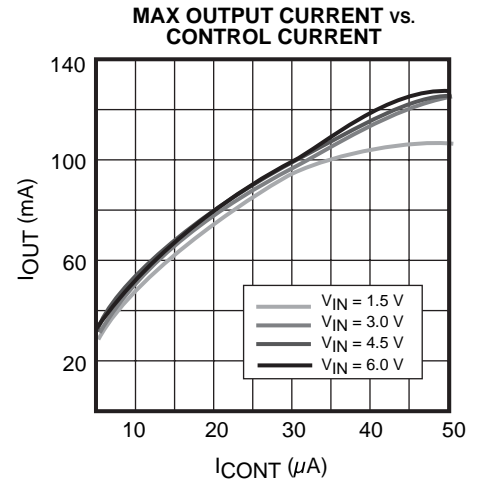
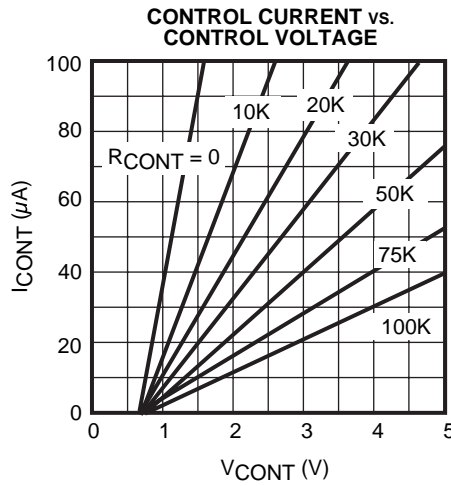
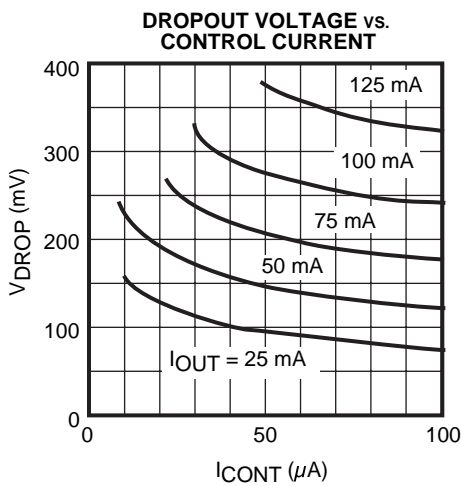

TYPICAL PERFORMANCE CHARACTERISTICS (CONT.)

GROUND CURRENT vs. OUTPUT CURRENT

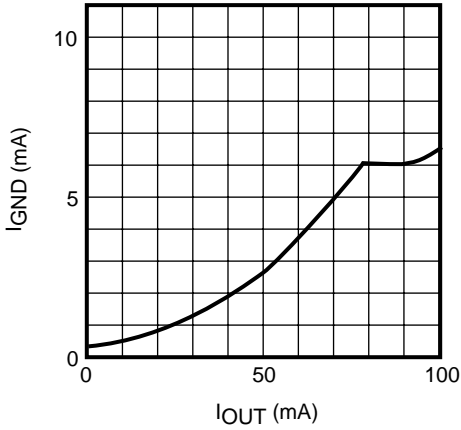

DROPOUT VOLTAGE vs. OUTPUT CURRENT

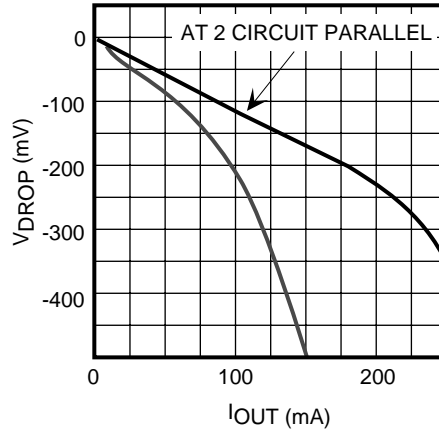

QUIESCENT CURRENT vs. INPUT VOLTAGE

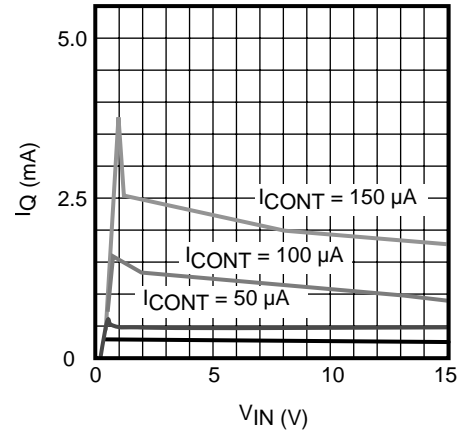

ON/OFF RESPONSE

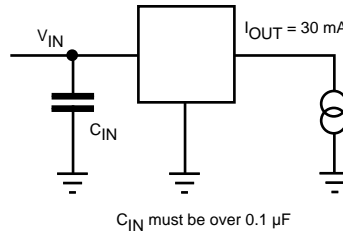
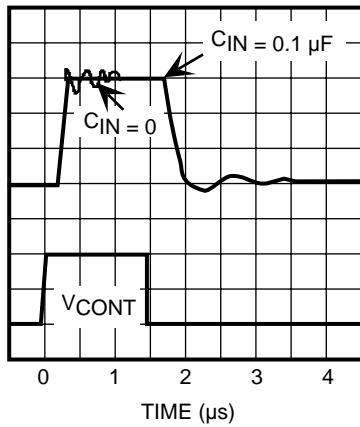

ON/OFF RESPONSE

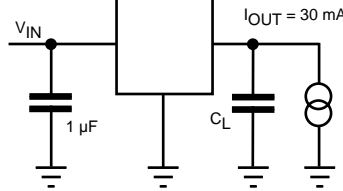
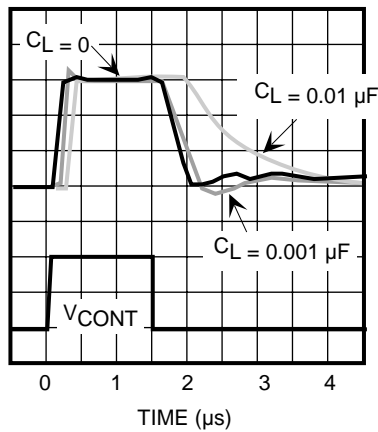

## TYPICAL PERFORMANCE CHARACTERISTICS (CONT.)

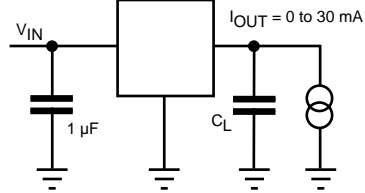
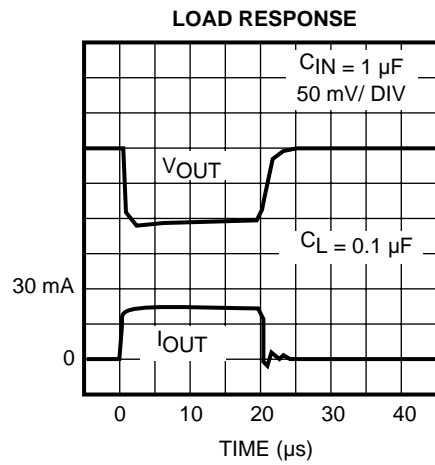

## DEFINITION AND EXPLANATION OF TECHNICAL TERMS

### DROPOUT VOLTAGE ( $V_{\text{DROP}}$ )

The output voltage decreases with the increase of output current. It is dependent upon the load current and the junction temperature. The dropout voltage is the difference between the input voltage and the output voltage. The measurement current is  $I_{\text{OUT}} = 50 \text{ mA}$ . ( $I_{\text{CONT}} = 50 \text{ }\mu\text{A}$ ,  $V_{\text{IN}} = 2.5 \text{ V}$ ).

### OUTPUT CURRENT ( $I_{\text{OUT}}$ )

The rated output current is specified under the condition where the output voltage drops 0.5 V below the no load value. The input voltage is set to 2.5 V, and the current is pulsed to minimize temperature effects.

### QUIESCENT CURRENT ( $I_{\text{Q}}$ )

The quiescent current is the current which flows through the ground terminal under no load conditions ( $I_{\text{OUT}} = 0 \text{ mA}$ ) with  $V_{\text{IN}} = 2.5 \text{ V}$  and excludes the control pin current.

### STANDBY CURRENT ( $I_{\text{STBY}}$ )

Standby current is the current which flows into the solid state switch when the output is turned off by the control function ( $V_{\text{CONT}} = 0 \text{ V}$ ). It is measured with  $V_{\text{IN}} = 8 \text{ V}$ .

### GROUND CURRENT ( $I_{\text{GND}}$ )

Ground current is the current which flows through the ground pin(s). It is defined as  $I_{\text{IN}} - I_{\text{OUT}}$ , excluding control current.

### ON/OFF CONTROL

High is "on" (referenced to ground). The input current is at the pA level by connecting the control terminal to ground.

### REVERSE VOLTAGE PROTECTION

Reverse voltage protection prevents damage due to the output voltage being higher than the input voltage. This fault condition can occur when the output capacitor remains charged and the input is reduced to zero, or when an external voltage higher than the input voltage is applied to the output side.

### ON/OFF CONTROL CURRENT

The characteristics of TK70001 change by the value of control current. Please refer to the electrical characteristics graphs on the data sheet and determine the optimum value. The standard measurement condition is  $I_{\text{CONT}} = 50 \text{ }\mu\text{A}$ . (The application is max.  $I_{\text{CONT}} = 200 \text{ }\mu\text{A}$ ). In the condition where there is very little output current, connect the resistor  $R_{\text{CONT}}$  to the control terminal (please consider the reduction of the terminal voltage, the resistance value, etc.). This current can be lowered.

### THERMAL SENSOR

The thermal sensor protects the device in the event that the junction temperature exceeds the safe value ( $T_{\text{J}} = 150 \text{ }^{\circ}\text{C}$ ). This temperature rise can be caused by external heat, excessive power dissipation caused by large input to output voltage drop, or excessive output current. The switch will shut off when the temperature exceeds the safe value. As the junction temperature decreases, the switch will begin to operate again. Under sustained fault conditions, the switch output will cycle as the device turns off, and then resets. Damage may occur to the device under extreme fault conditions.

### PACKAGE POWER DISSIPATION ( $P_{\text{D}}$ )

This is the power dissipation level at which the thermal sensor is activated. The IC contains an internal thermal sensor which monitors the junction temperature. When the junction temperature exceeds the monitor threshold of  $150 \text{ }^{\circ}\text{C}$ , the IC is shut down. The junction temperature rises as the difference between the input power ( $V_{\text{IN}} \times I_{\text{IN}}$ ) and the output power ( $V_{\text{OUT}} \times I_{\text{OUT}}$ ) increases. The rate of temperature rise is greatly affected by the mounting pad configuration on the PCB, the board material, and the ambient temperature. When the IC mounting has good thermal conductivity, the junction temperature will be low even if the power dissipation is great. When mounted on the recommended mounting pad, the power dissipation of the SOT-26 is increased to 350 mW. For operation at ambient temperatures over  $25 \text{ }^{\circ}\text{C}$ , the power dissipation of the SOT-26 device should be derated at  $2.8 \text{ mW}/^{\circ}\text{C}$ . To determine the power dissipation for shutdown when mounted, attach the device on the actual PCB and deliberately increase the output current (or raise the input voltage) until the thermal protection circuit is activated. Calculate the power dissipation of the device by subtracting the output power from the input power. These

## DEFINITION AND EXPLANATION OF TECHNICAL TERMS (CONT.)

measurements should allow for the ambient temperature of the PCB. The value obtained from  $P_D / (150^\circ\text{C} - T_A)$  is the derating factor. The PCB mounting pad should provide maximum thermal conductivity in order to maintain low device temperatures. As a general rule, the lower the temperature, the better the reliability of the device. The thermal resistance when mounted is expressed as follows:

$$T_j = \theta_{jA} \times P_D + T_A$$

For Toko ICs, the internal limit for junction temperature is  $150^\circ\text{C}$ . If the ambient temperature ( $T_A$ ) is  $25^\circ\text{C}$ , then:

$$150^\circ\text{C} = \theta_{jA} \times P_D + 25^\circ\text{C}$$

$$\theta_{jA} = 125^\circ\text{C} / P_D$$

$P_D$  is the value when the thermal sensor is activated. A simple way to determine  $P_D$  is to calculate  $V_{IN} \times I_{IN}$  when the output side is shorted. Input current gradually falls as temperature rises. You should use the value when thermal equilibrium is reached.

The range of usable currents can also be found from the graph below.

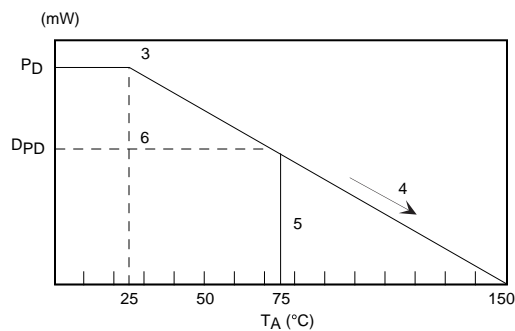

Procedure:

- 1) Find  $P_D$
- 2)  $P_{D1}$  is taken to be  $P_D \times (\sim 0.8 - 0.9)$
- 3) Plot  $P_{D1}$  against  $25^\circ\text{C}$
- 4) Connect  $P_{D1}$  to the point corresponding to the  $150^\circ\text{C}$  with a straight line.
- 5) In design, take a vertical line from the maximum operating temperature (e.g.,  $75^\circ\text{C}$ ) to the derating curve.
- 6) Read off the value of  $P_D$  against the point at which the vertical line intersects the derating curve. This is taken as the maximum power dissipation,  $D_{PD}$ .

The maximum operating current is:

$$I_{OUT} = (D_{PD} / (V_{IN(MAX)} - V_{OUT}))$$

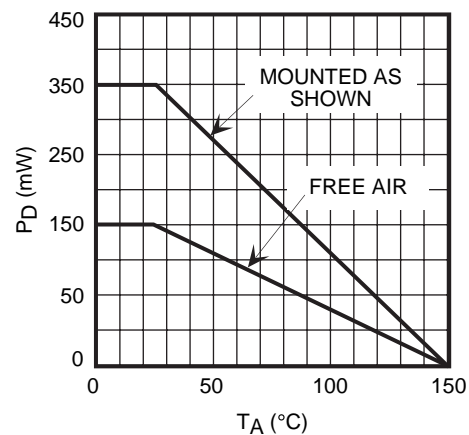

### SOT-26 POWER DISSIPATION

## APPLICATION INFORMATION

### BOARD LAYOUT

The copper pattern should be as large as possible.

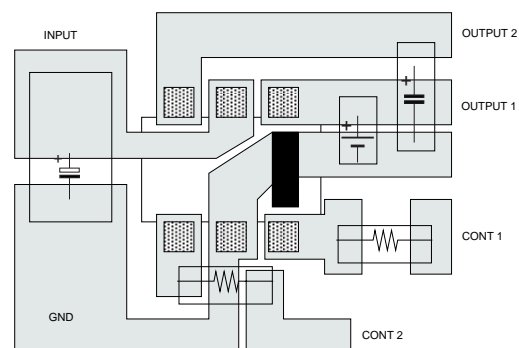

PCB: CLASS EPOXY T=0.8 mm

### SOT-26 BOARD LAYOUT

PACKAGE OUTLINE

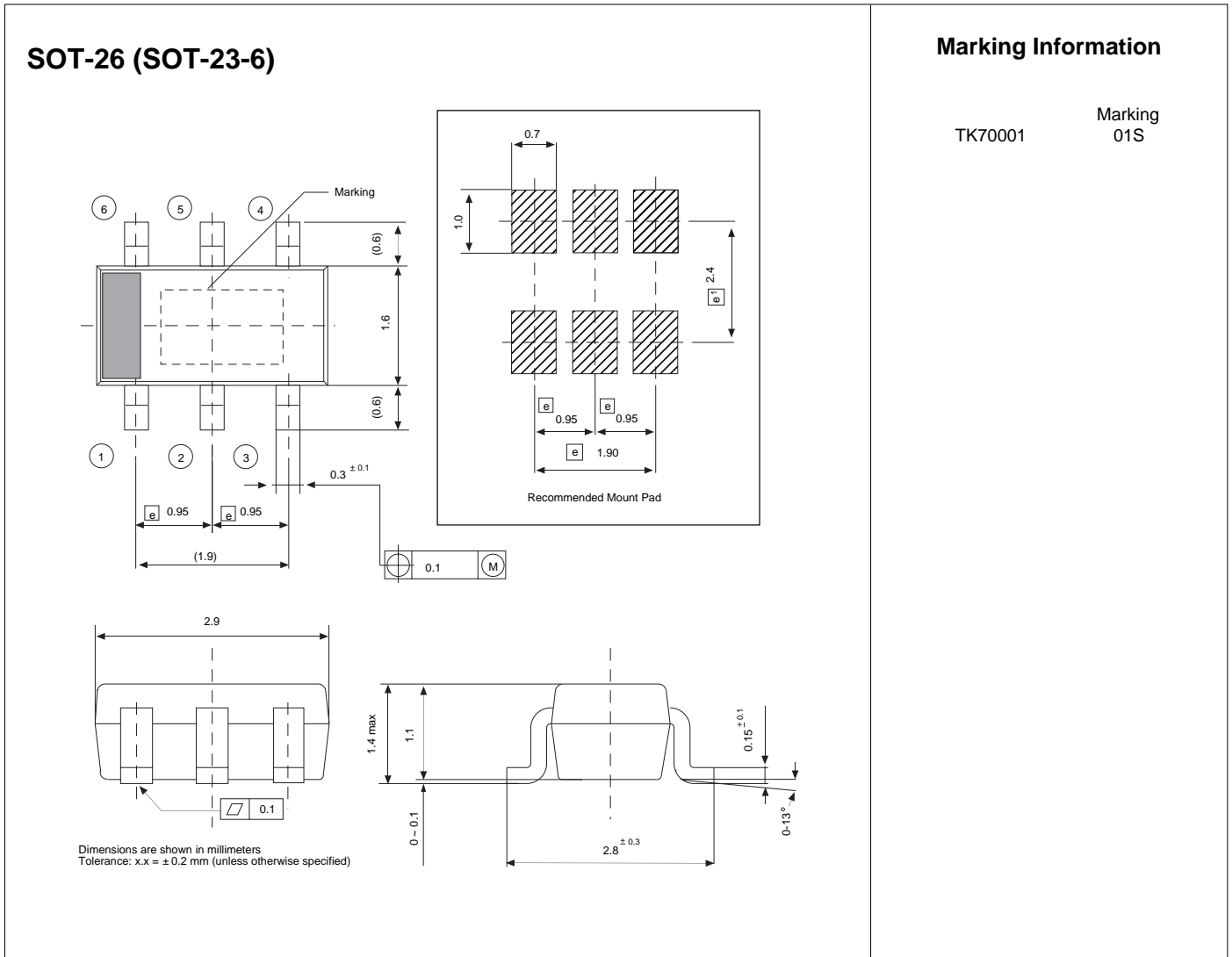

Toko America, Inc. Headquarters  
1250 Feehanville Drive, Mount Prospect, Illinois 60056  
Tel: (847) 297-0070 Fax: (847) 699-7864

TOKO AMERICA REGIONAL OFFICES

Midwest Regional Office  
Toko America, Inc.  
1250 Feehanville Drive  
Mount Prospect, IL 60056  
Tel: (847) 297-0070  
Fax: (847) 699-7864

Western Regional Office  
Toko America, Inc.  
2480 North First Street, Suite 260  
San Jose, CA 95131  
Tel: (408) 432-8281  
Fax: (408) 943-9790

Eastern Regional Office  
Toko America, Inc.  
107 Mill Plain Road  
Danbury, CT 06811  
Tel: (203) 748-6871  
Fax: (203) 797-1223

Semiconductor Technical Support  
Toko Design Center  
4755 Forge Road  
Colorado Springs, CO 80907  
Tel: (719) 528-2200  
Fax: (719) 528-2375

Visit our Internet site at <http://www.tokoam.com>

The information furnished by TOKO, Inc. is believed to be accurate and reliable. However, TOKO reserves the right to make changes or improvements in the design, specification or manufacture of its products without further notice. TOKO does not assume any liability arising from the application or use of any product or circuit described herein, nor for any infringements of patents or other rights of third parties which may result from the use of its products. No license is granted by implication or otherwise under any patent or patent rights of TOKO, Inc.